

FOLDING MAST & BOOM

July 2011



Portable
Boat
Plans
.com

NO Stays Required

It seems inevitable that for a portable boat that fits in the family vehicle, the sailing version should have a mast and boom that does the same thing. Past attempts at this were specific to a particular boat.

Now, I am introducing a design that can be universal in nature. It can be used, with minor modifications, on any small sail boat design, past, present or future.

Review the following and see if it satisfies your specific needs.

Basically, I have taken a simple, yet ridged 12 foot mast and made it into a folding design that is now 6 feet in length.

This idea can be scaled up, or down, with a 16 foot maximum length mast recommended.

Construction of the Boom is first, as it is simpler and will prepare you for the Mast assembly.

It bears repeating that the design as shown can be modified to suit the builders requirements.

The design is for a sail of approximately 30 square feet in area. If you want a larger sail, and the hull can handle it, then you will have to make the boom longer and the mast higher.

The fittings should be beefed-up accordingly, to withstand the higher forces.

The rig as depicted is intended for easy transport, and the folded mast should fit in most vehicles.

BOOM CONSTRUCTION

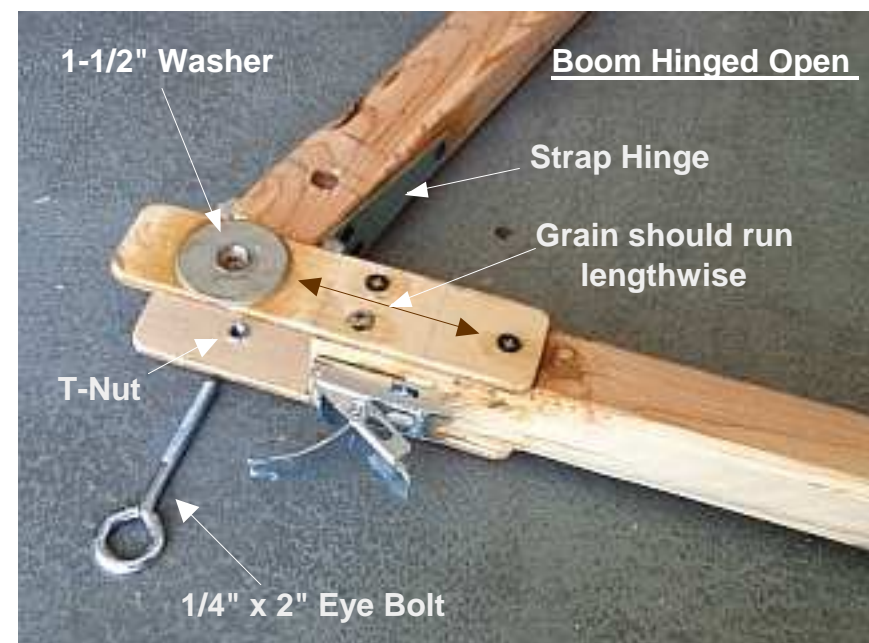
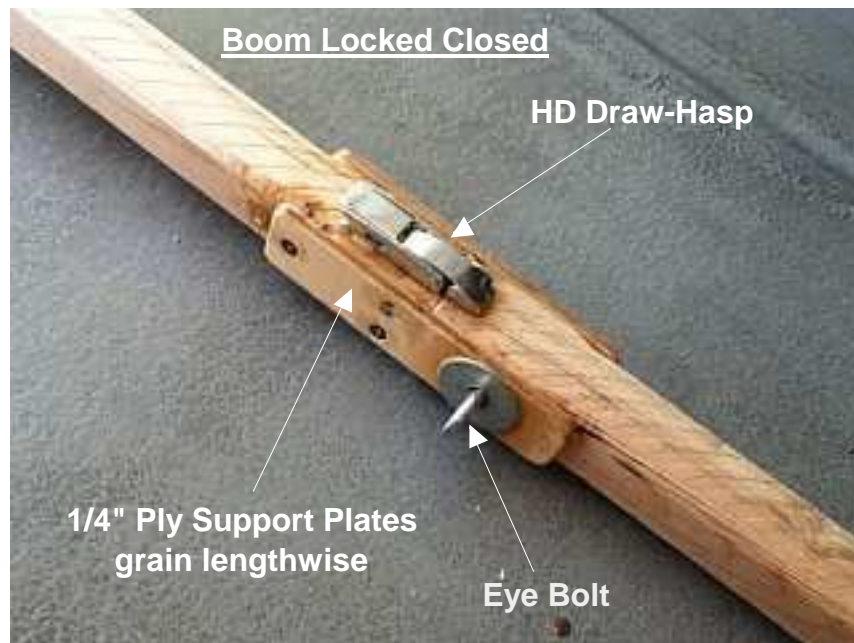

The purpose of the duple-layer mast and single layer boom is simple: It utilizes small readily available components, but is strong, has low weight, and is inexpensive to make. Best of all, when folded, it all fits in your vehicle.

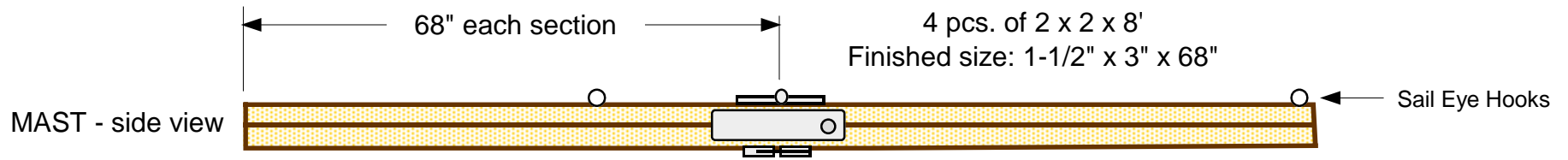

**View Photos
for more
detail**

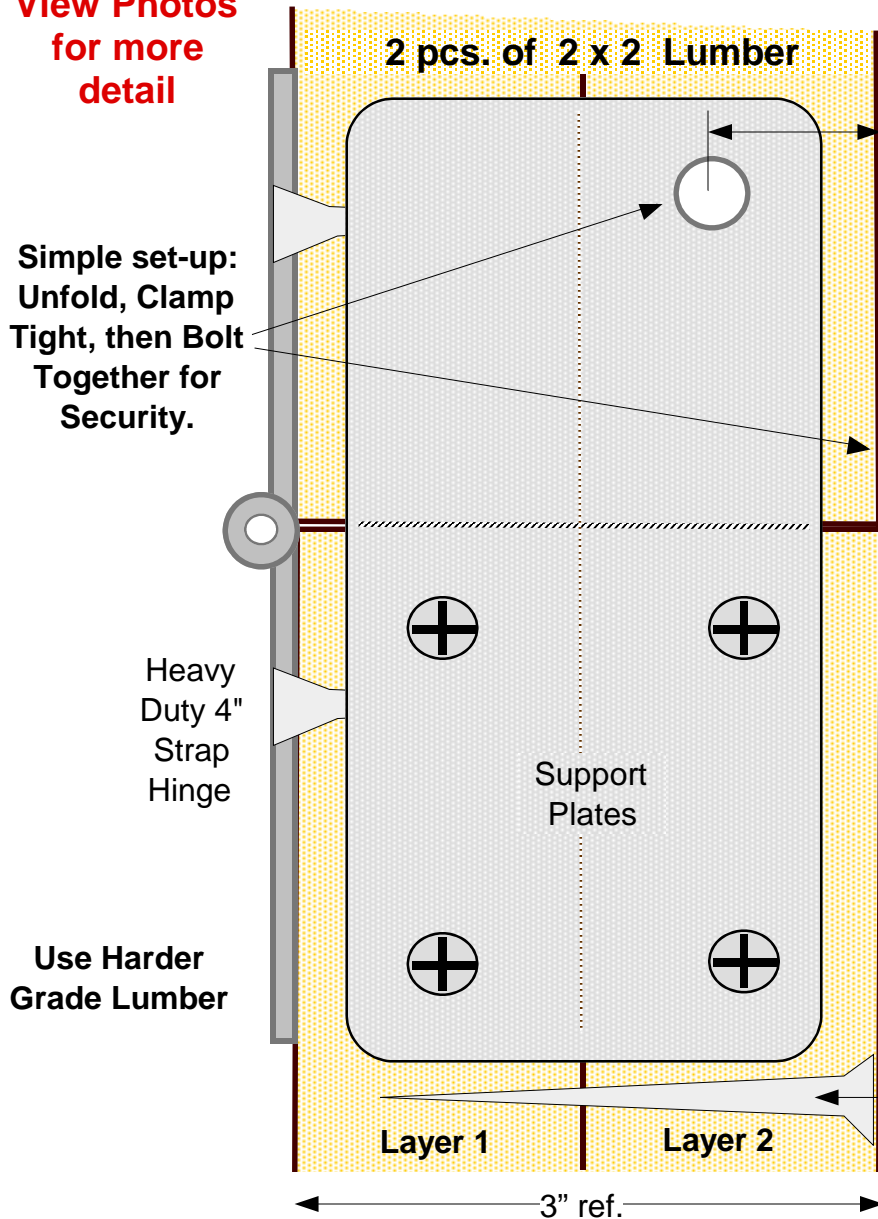

Fold-in-Half MAST

**Make the grain
of one section
layer opposite
the grain of the
other section.
Provides extra
strength in both
directions.**

**The 7 foot single
piece Boom is
made in a
similar fashion,
and folds to less
than 4 feet
length.**

**BOW
Side**

Draw Tight
Clamp

2-1/2" screws
staggered every
12 inches. Pilot
drill and c'sink.

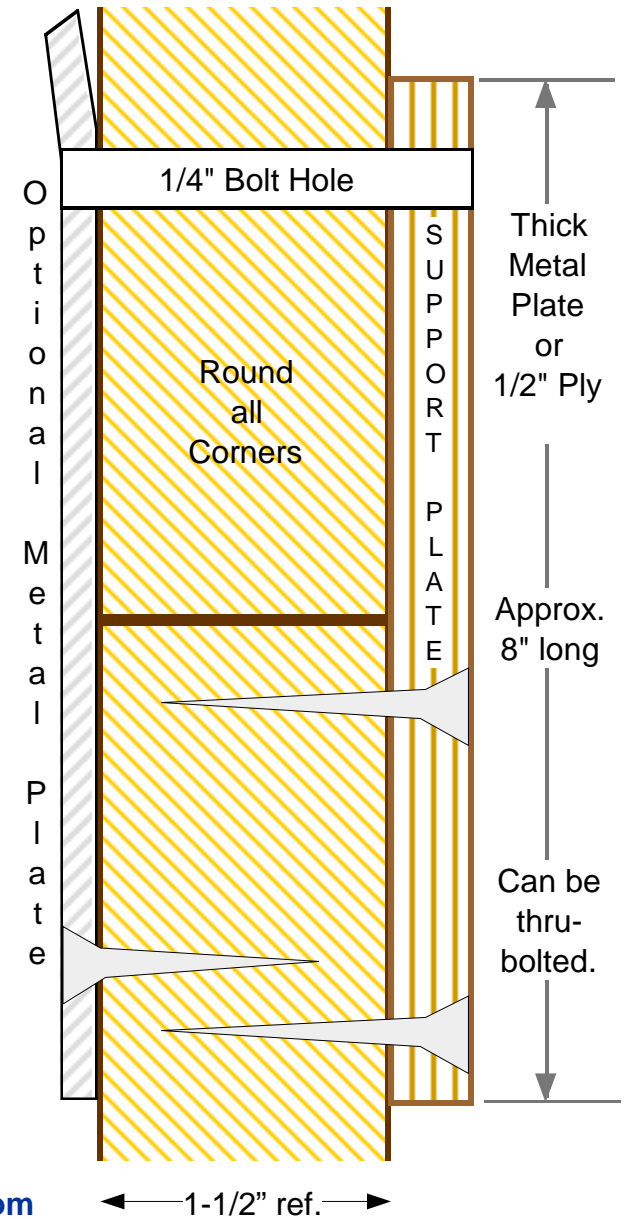

MAST Details

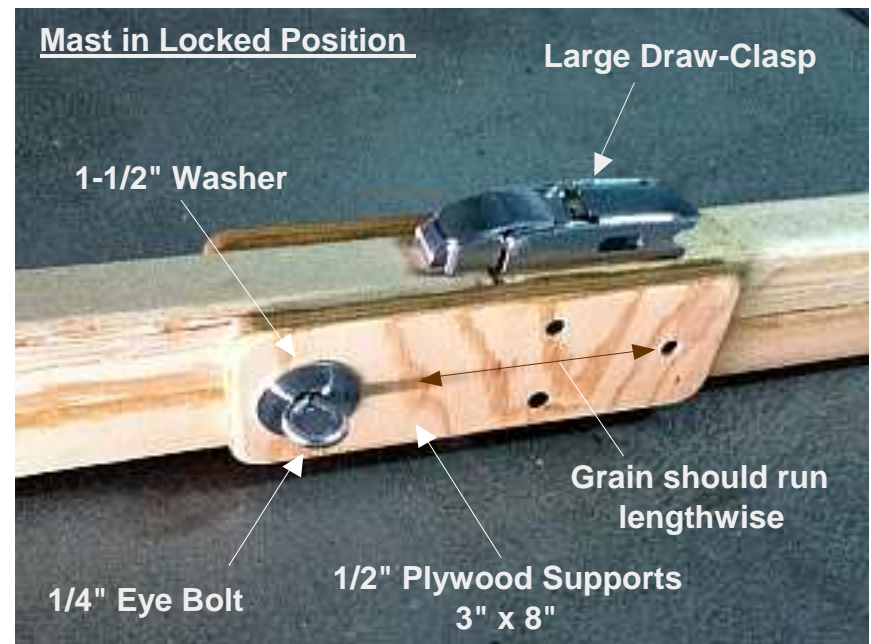

The purpose for the Eye Bolt is to be able to easily tighten it without a tool, and to retain it with a lanyard so it won't become lost.

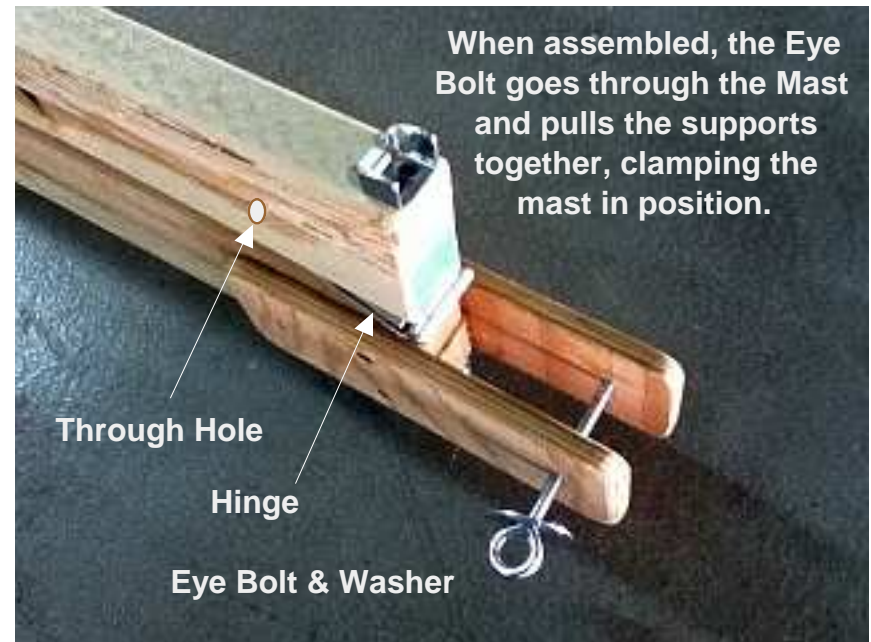
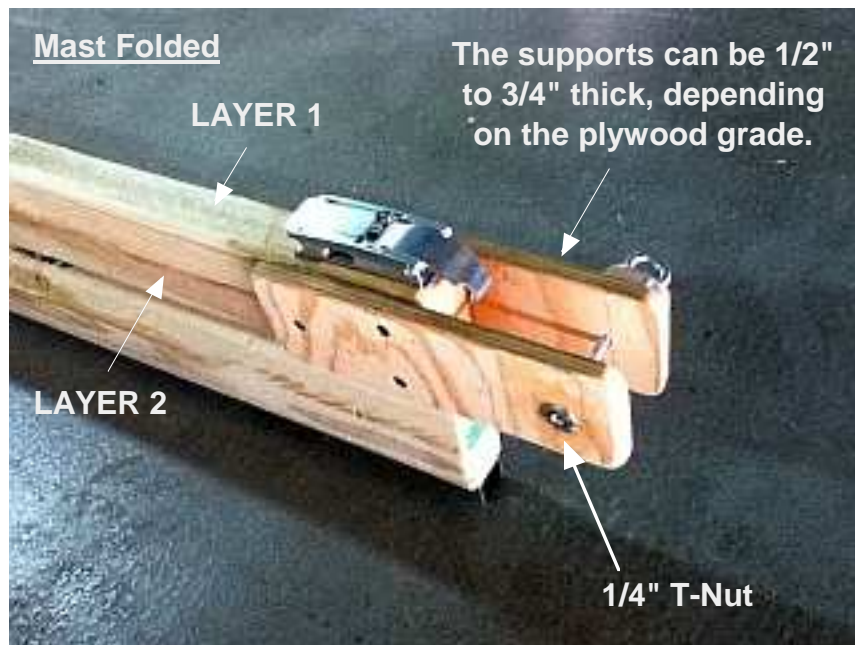

AT THE WATER PHOTOS



As you can see, the mast is easy to unfold and extend while at the water's edge. Setting the boom in place is a matter of snapping it into an eye on the mast. The 2 part mast is both rugged and reasonably lightweight, and easily fits into many different hull designs. Simplicity is always a key factor in my designs, and the folding mast and boom follow that philosophy.



Mast ready to be un-folded



Under a light breeze, heading back to the ramp.



T-Nuts, 3/8-16 and 1/4-20 thd. \$3
Use as fixed nuts for Security Bolts and Mast Bolts.



4" Strap Hinge, 1-1/2" wide, 2 reqd. \$6 (Mast & Boom)
Zinc plated steel.

Prices shown are rounded up, and are for the total of each category.



#6 Screw Eyes, 1" thd., 8 reqd. \$6 (Mast & Boom)

4" x 1-1/8"
wide Draw
Hasp, 2 reqd.
\$10
Zinc Plated
Steel (Mast &
Boom)



Substitutes are OK,
just maintain
minimum strength
requirements.

NOTES

It is the intent of the designer to provide construction ideas that will prove beneficial to the small home built boating community. I have built and tested this assembly, and find it to be adequate for small boats.

I strongly recommend that you make changes to the design to improve it, or to compliment your specific application.

One of the boats that could benefit from this design is the PDRacer, by Shorty Routh. My version of his design is the Modular PDRacer, available for free on my website, with only a lengthening of the mast to accommodate a larger sail.

These plans are also free, and can be downloaded from: www.PortableBoatPlans.com

COMMENTS:

July 2011

FOLDING MAST RETROFIT OPTION for TOTER 2

NO Stays Required

MAST SUPPORT

BOW side

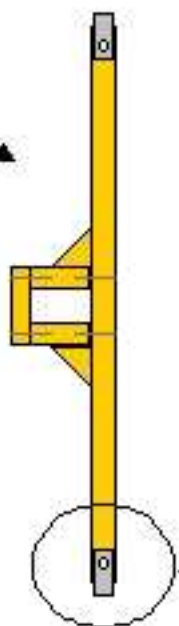

Mast support made of harder grade 2 x 3 lumber.

1/8" Steel Strap (bend to fit)

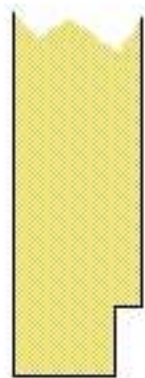
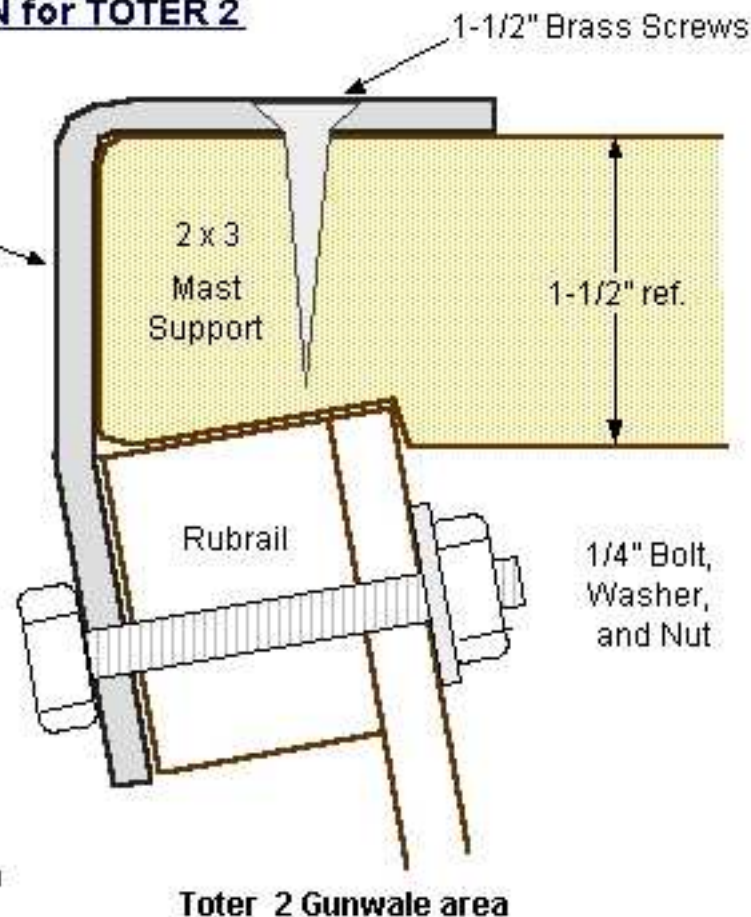

Notch the Folding Mast to fit in the existing Step. Fit a wedge, on either side of mast, into the existing step, to secure.

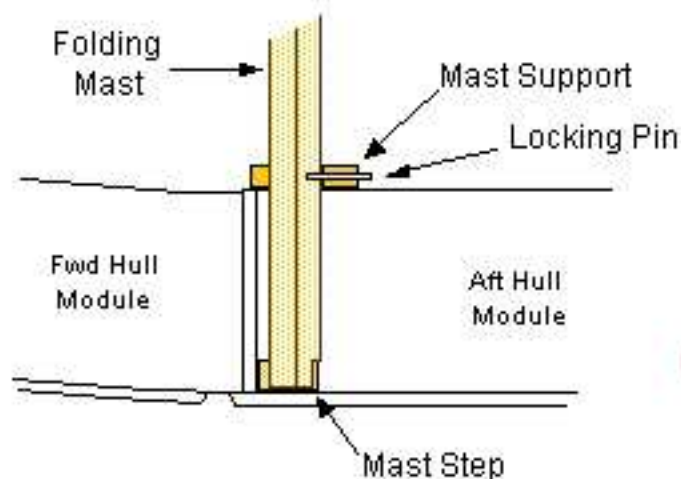

Go to: www.PortableBoatPlans.com and download the free plans for the Folding Mast in the Accessories section of the main page.

It is necessary to extend the Forward Deck to 14" min, as shown. This can be done while building, or, if the deck is already in place, add a 4 inch extension.

ADD a 1 x 2 underneath, on edge, to support this edge of the deck .

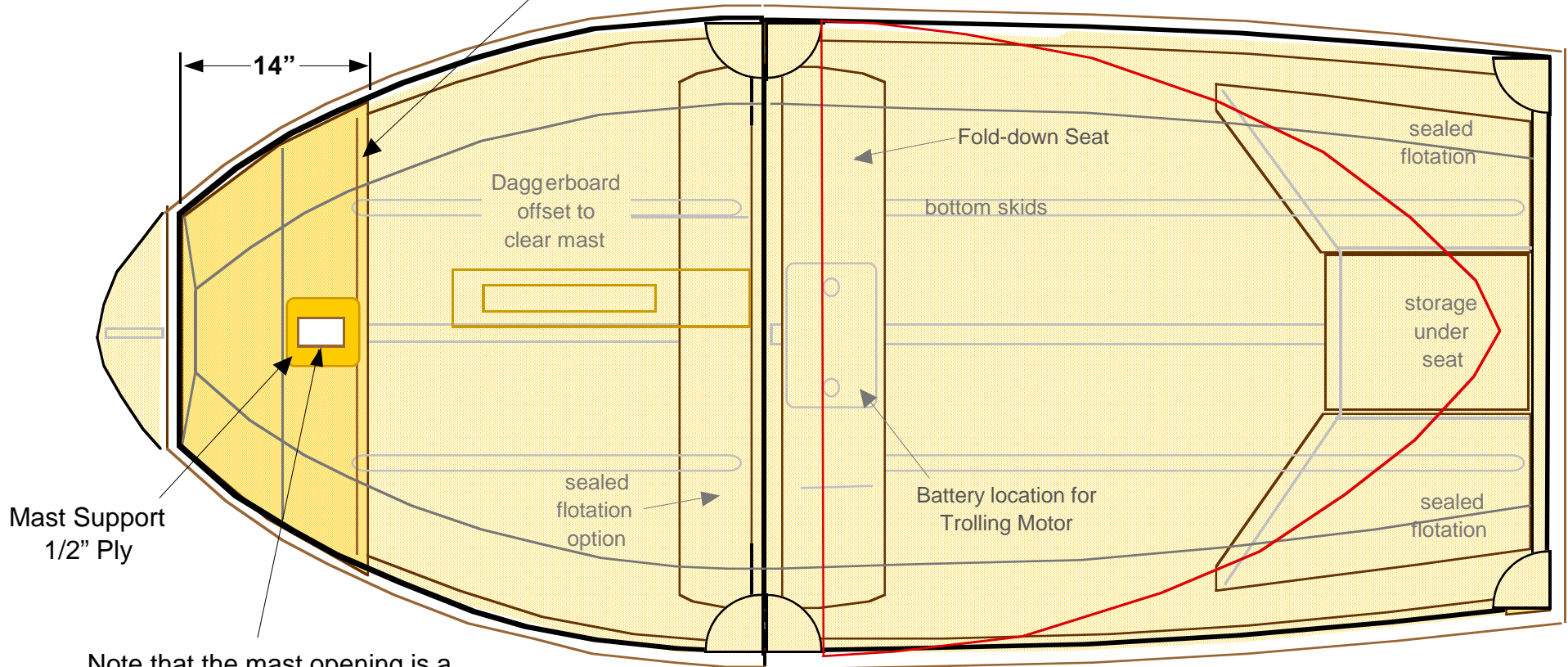

Note that the mast opening is a different size, approx. 1-1/2" x 3"

If you already made the Mast Step, it will have to be modified to suite the new mast size.

Go to www.PortableBoatPlans.com and download the **FOLDING MAST & BOOM** Plans from the **Accessory Plans** section, near the end of the main page.

The designed height of the Folding Mast is 12 feet, the same as the original Pollywog Mast. You can choose to increase this up to 16 feet maximum, for use of a larger sail. Of course, this means the mast, when folded, would be 8 feet in length, and this is longer than most vehicles can carry inside. The choice is yours.

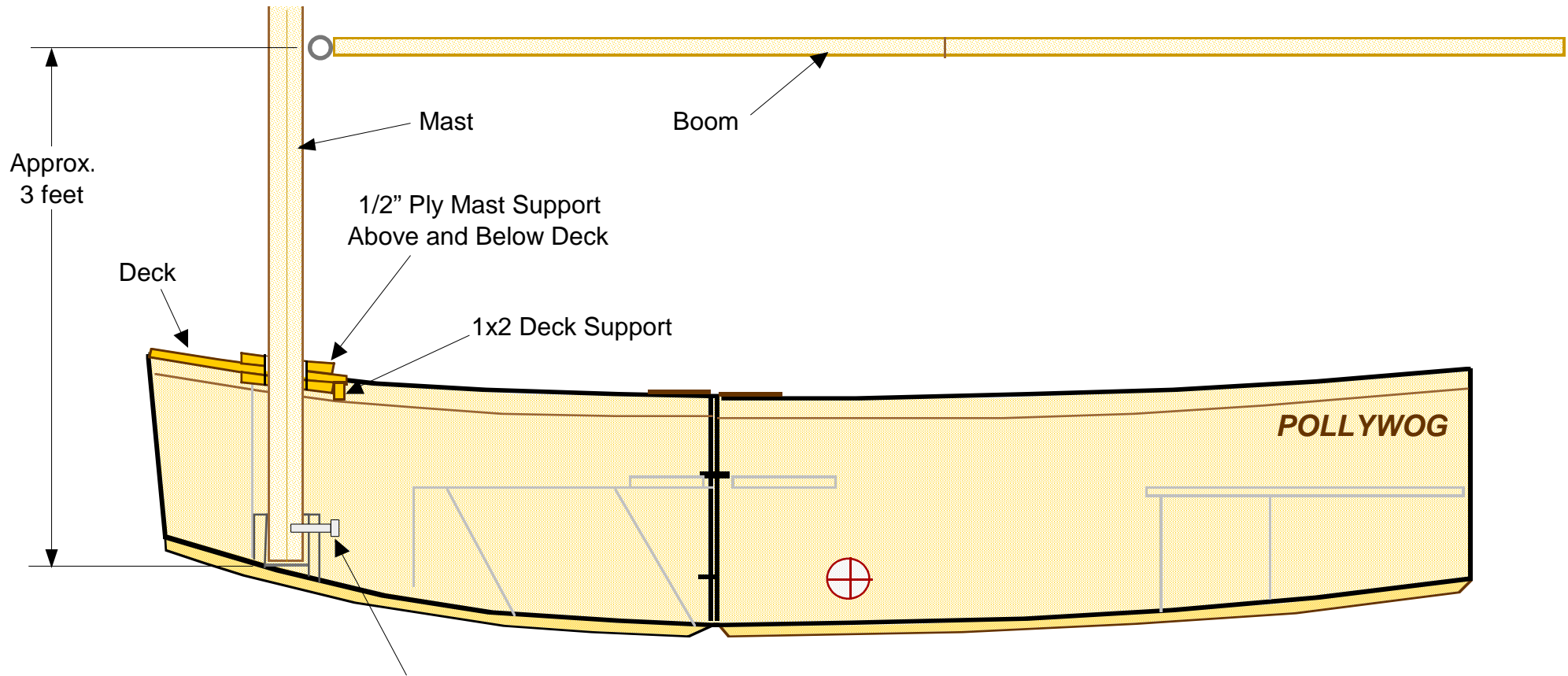

It is also strongly recommended that a removable 1/4" locking pin be used to prevent the mast from rising out of the step during sailing operation.

You will also have to extend the length of the Boom, as described on the Folding Boom Plans, to about 9 feet in length, to agree with the POLLYWOG specifications..

All other features and dimensions of the POLLYWOG remain the same. The biggest change is that no Mast Stays will be required, and the ease of installing and raising the mast will be greatly enhanced.